

RoHS COMPLIANT

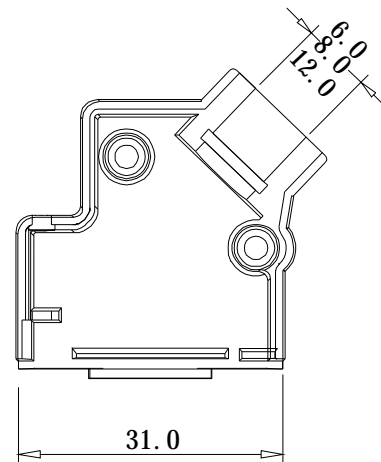

PART NO.:  
 B05-009NN809-XXE  
 出线OD: \_\_\_\_\_  
 B6: 出线孔6.0  
 B8: 出线孔8.0  
 BC: 出线孔12.0  
 C5: 出线孔12.0配5.0黑色线卡  
 C6: 出线孔12.0配6.0黑色线卡  
 C7: 出线孔12.0配7.0黑色线卡  
 C8: 出线孔12.0配8.0黑色线卡  
 C9: 出线孔12.0配9.0黑色线卡  
 CA: 出线孔12.0配10.0黑色线卡

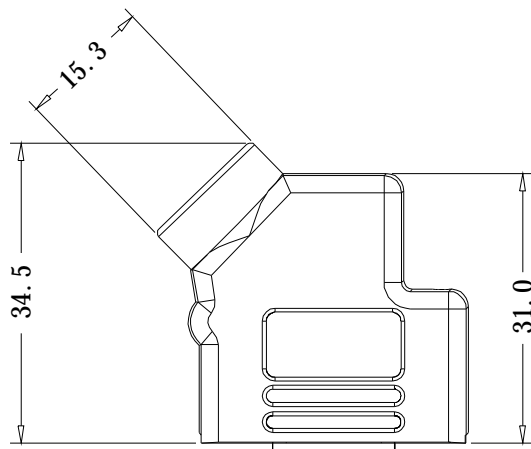
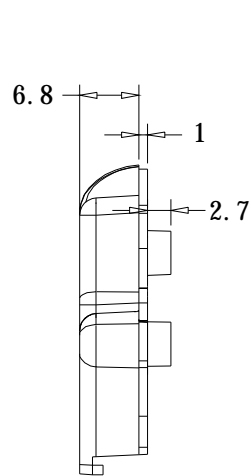
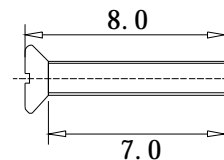
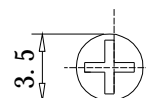
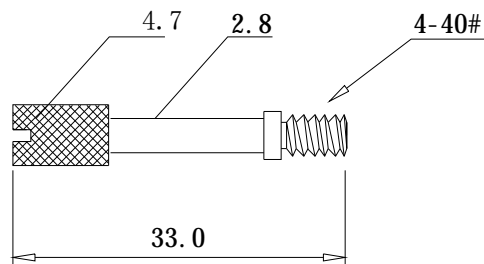
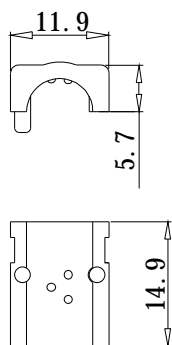

4	塑胶线卡	ABS	COLOR: BLACK	2PCS
3	螺丝#4-40 UNC	STEEL	PLATING: Ni	1PCS
2	十字螺丝	STEEL	PLATING: Ni	2PCS
1	上下外壳	ZINC	PLATING: Ni	1SET
ITEM	DESC.	MATERIAL	REMAKS	PART REMAKS

△	2023/02/10	增加塑胶线卡	JACK CHEN
△	2013/01/26	新版发行	JACK CHEN
SIDE	DATE	DESCRIPTION	APPROVER
8	7	6	5

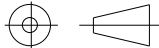
QUALITY SYMBOLS		Tolerance		NAME: D-SUB 09P 锌合金外壳45° 出线单边螺丝 (客户用图)				PART NO. B05-009NN809-XXE			
□:	☒:	x.	±0.80	REV:	B	UNIT:	mm	DRW BY	CHK BY	APP BY	DRAWING NO.
CRITICAL	MAJOR	.x	±0.50	SCALE:	N:1	DATE:	2013/01/26	Huangmei	Jack Chen		B05-043
▽:	▽:	.xx	±0.25	 东莞市林诚塑胶电子有限公司 <a href="http://www.lineconn.com">http://www.lineconn.com</a> TEL: 0769-85181660 85181770							
ZERO DEFECT	S.P.C			4		3		2		1	