

RoHS COMPLIANT

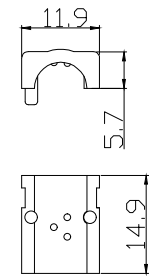

④

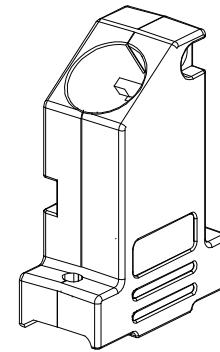
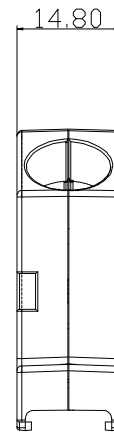
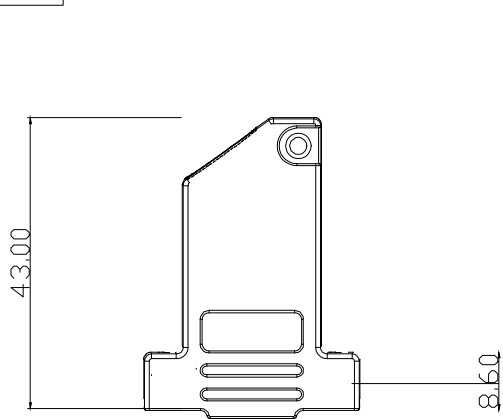
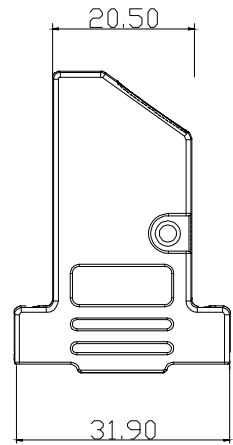
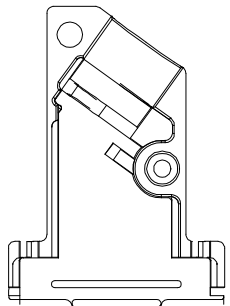

①

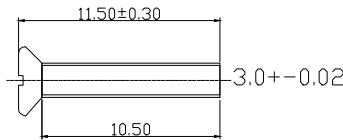
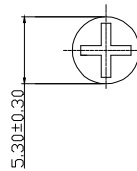
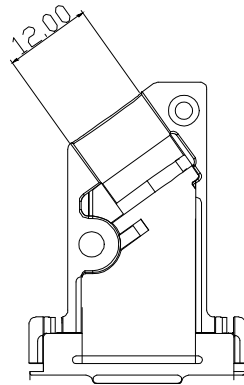

②

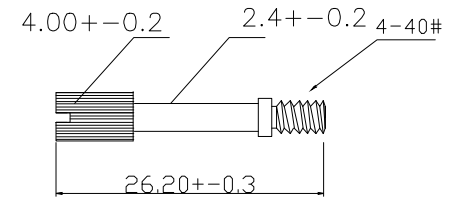

③

PART NO.:
B05-009NN8N9-XXE

ENTRY HOLE SIZES:
60:OD 6.0mm
80:OD 8.0mm
1A:OD 10.0mm

ITEM	DESC.	MATERIAL	REMAKS	PART REMAKS
4	塑胶线卡	ABS	COLOR: BLACK	2PCS
3	十字螺丝	STEEL	PLATING: Ni	2PCS
2	螺丝#4-40 UNC	STEEL	PLATING: Ni	2PCS
1	上下外壳	ZINC	PLATING: Ni	1SET

QUALITY SYMBOLS
□: □: : :
CRITICAL MAJOR
▽: ▽:
ZERO DEFECT S.P.C

Tolerance	
x.	±0.80
.x	±0.50
.xx	±0.25

NAME:	D-SUB 09P 锌合金外壳45°出线 (客户用图)				PART NO.	B05-009NN8N6-XXB		
REV:	A	UNIT:	mm	DRW BY	CHK BY	APP BY	DRAWING NO.	
SCALE:	N:1	DATE:	2013/04/12	JING LI	JACK CHEN		B05-044	

Lineconn 东莞市林诚塑胶电子有限公司 <http://www.lineconn.com>
TEL:0769-85181660 85181770

SIDE	DATE	DESCRIPTION	APPROVER
△	2013/04/12	新版发行	JACK CHEN